

Motorised butterfly valve DMK Nominal Diameters DN 40 to DN 125

DUNGS[®]
Combustion Controls

11.11

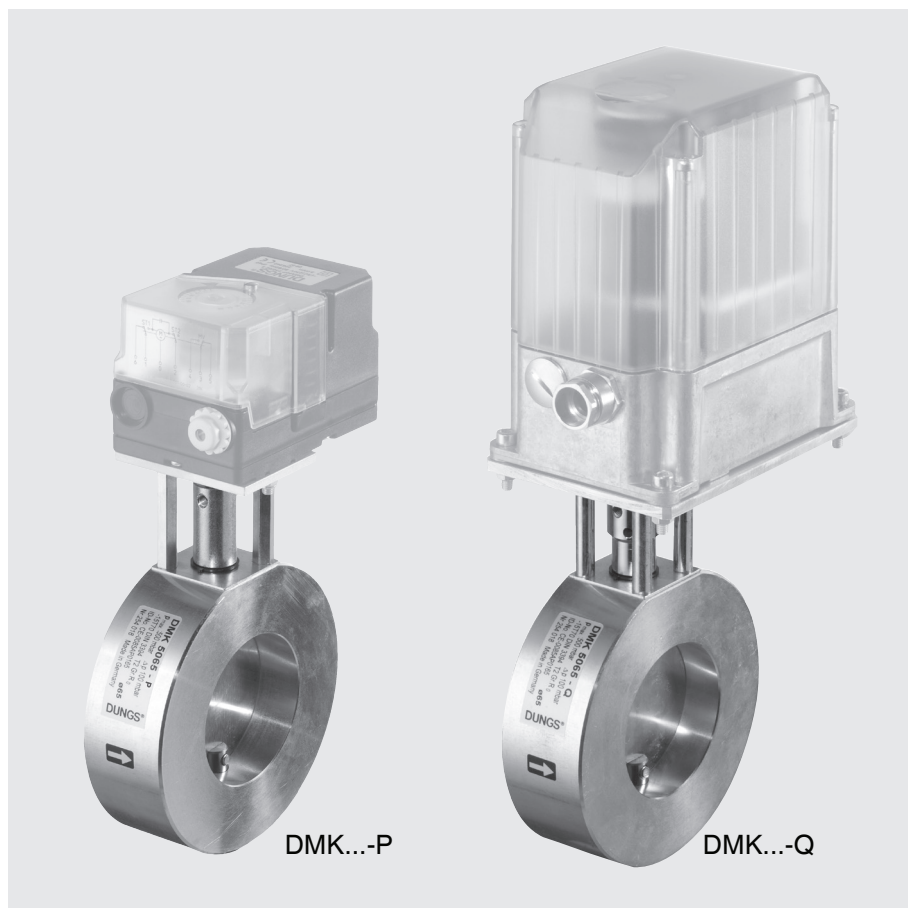

Technical description

The DUNGS DMK... motorised butterfly valve is an actuator without zero shut-off as per DIN 3394 Sheet 2.

The intermediate-flange design saves space when it is mounted directly on DUNGS multiple actuators, solenoid valves and other valves:

- max. operating pressure
500 mbar (50 kPa)
- max. differential pressure
250 mbar (25 kPa)
- group R₀ as per DIN 3394 Sh. 2
- standard actuator drives:
DMA...P..., DMA...Q...
other drives available on request.

Application

The DUNGS DMK... motorised butterfly valve is used for controlling the gas supply to gas burners and gas-burning appliances. The motorised butterfly valve is suitable for gases of families 1, 2, 3 and other neutral gaseous media.

Free of non-ferrous metals, suitable for gases up to max. 0.1% by vol. H₂S, dry.

Approvals

EC type test approval as per EC Gas Appliance Directive:

DMK 5... CE-0085 AP0165
Approvals in other important gas consuming countries.

DMK	Actuator with no zero shut-off for control tasks. Prepared for mechanical and electromechanical actuator drives.
------------	--

Technical data

Nominal diameters	DN 40 50 65 80 100 125 Intermediate flange to fit preweld flange as per DIN EN 1092-1
Max. operating pressure	500 mbar (50 kPa)
Max. differential pressure	250 mbar (25 kPa)
Actuator	Actuator as per DIN 3394 Sh. 2, Group R ₀
Gap volume flow in closed position (O°)	see Diagram 1
Torque	min. 150 Ncm
Adjusting angle	max. 90°
Throat valve diameters	DMK 5040 40 mm DMK 5050 50 mm DMK 5065 65 mm DMK 5080 80 mm DMK 5100 100 mm DMK 5125 125 mm
Gas-conveying component materials	Housing Aluminium Shaft Steel Seals NBR
Ambient temperature	-15 °C to +70 °C
Installation position	Any installation position; comply with technical data of actuator drive

For technical data of actuator drives type DMA... P/Q..., see Data Sheet 11.20

Functional description

The DUNGS motorised butterfly valve is an automatic actuator driven by auxiliary energy.

The electromechanical actuator drive determines the butterfly valve position.

Valve partial load and full load adjustment is defined by adjusting the related actuator drive switching cams.

The actuating time depends on the actuator drive selected.

If the operating voltage (auxiliary energy) is interrupted, the actuator remains in its current position.

Installation

- When installing, refer to the flow direction arrow on the housing.
- Keep to the specified installation position.

 **Avoid direct contact between the motorised butterfly valve and dried masonry, concrete walls or floors.**

 **Only set the nominal pressure on the pressure regulator. Any output-related restriction should only be performed using the motorised butterfly valve.**

 **Check for leaks and function after installation.**

k_v values of valves with preferred throat diameters

Preferred diameters [mm]	DMK 5040	DMK 5050	DMK 5065	DMK 5080	DMK 5100	DMK 5125
Valve position	90° 0°	90° 0°	90° 0°	90° 0°	90° 0°	90° 0°
40	102.2 0.85					
50		131.4 1.35				
65			255.5 2.59			
80				357.7 3.28		
100					565.75 4.0	
125						1204.5 5.48

Selecting the device

You must know the following values to select the DMK variant:

1. Maximum volume flow V_{max}
2. Pressure loss Δp at maximum volume flow
3. Minimum volume flow V_{min}
4. Differential pressure in the closed valve position ($= p_e$)

You can either determine the throat diameter by calculation using the k_v value or using diagrams 1, 2, 3 and 4.

Check whether the required minimum volume flow is reached when the valve is positioned at 0°. If the calculated or measured value is below the required minimum volume flow, the valve can be used.

If the volume flows are small, the pressure loss of upstream devices will fall. This increases the Δp available to the valve. To obtain an optimum control response, always choose the valve with the largest pressure loss ($\Delta p > 10$ mbar).

K_v value for DMK motorised butterfly valve

The DMK motorised butterfly valve is limited by the following parameters:
 operating pressure $p_{max} = 500$ mbar (50 kPa)
 differential pressure $\Delta p_{max} = 250$ mbar (25 kPa)

When the valve is used in subcritical flow states, the following applies:

V_N [m³/h]
volume flow, standard state
 Δp [bar]
pressure drop across DMK
 p_2 [bar]
absolute pressure downstream of DMK
 ρ_n [kg/m³]
standard gas density
 T_1 [K]
absolute gas temperature upstream of DMK

$$V_n = 514 \cdot k_v \cdot \sqrt{\frac{\Delta p \cdot p_2}{\rho_n \cdot T_1}}$$

Flow diagram 1
DMK 5040 - DMK 5125
 V_{min} valve position 0°
 Valve closed

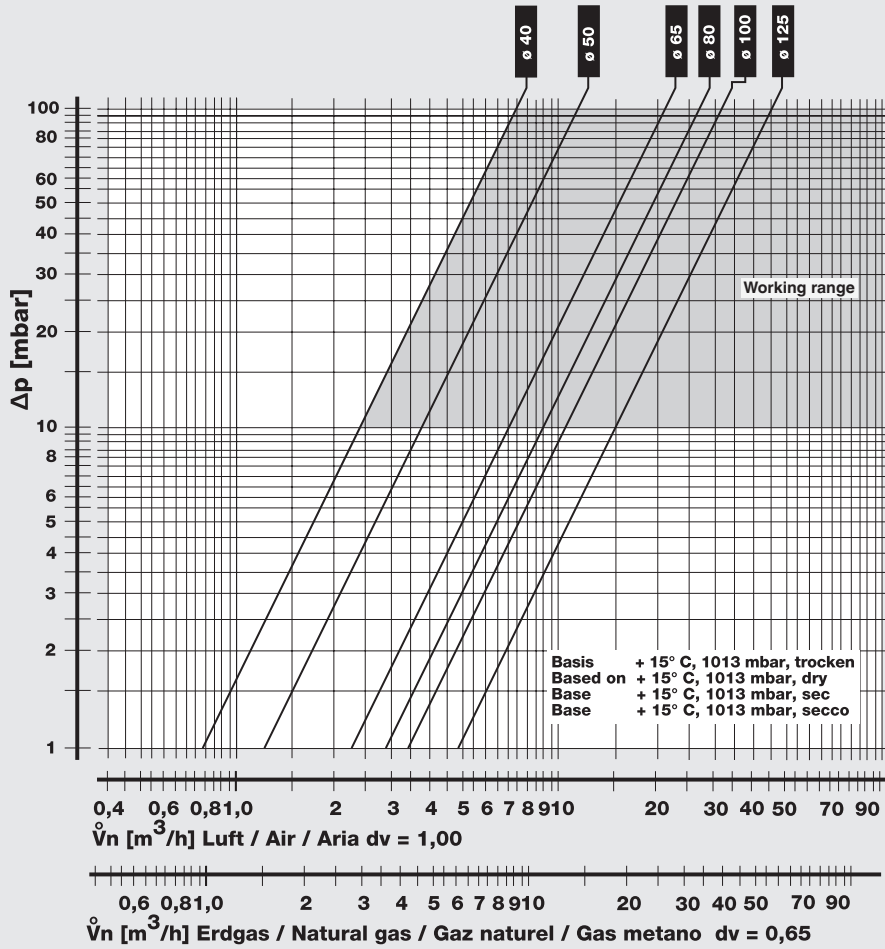

Flow diagram 2
DMK 5040 - DMK 5080
 V_{max} valve position 90° ,
 Valve open

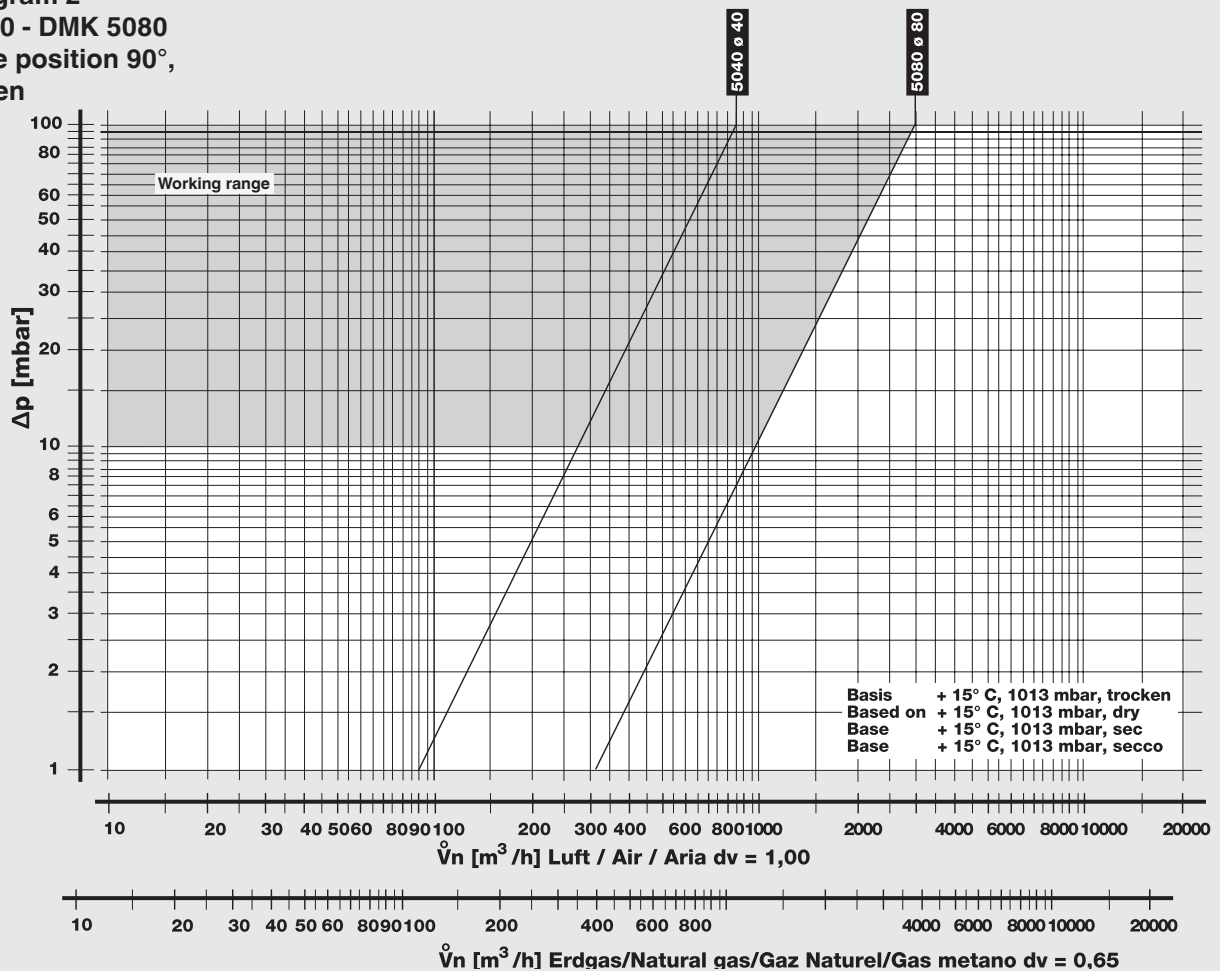

Flow diagram 3
DMK 5050, DMK 5100
 V_{max} valve position 90°
 Valve open

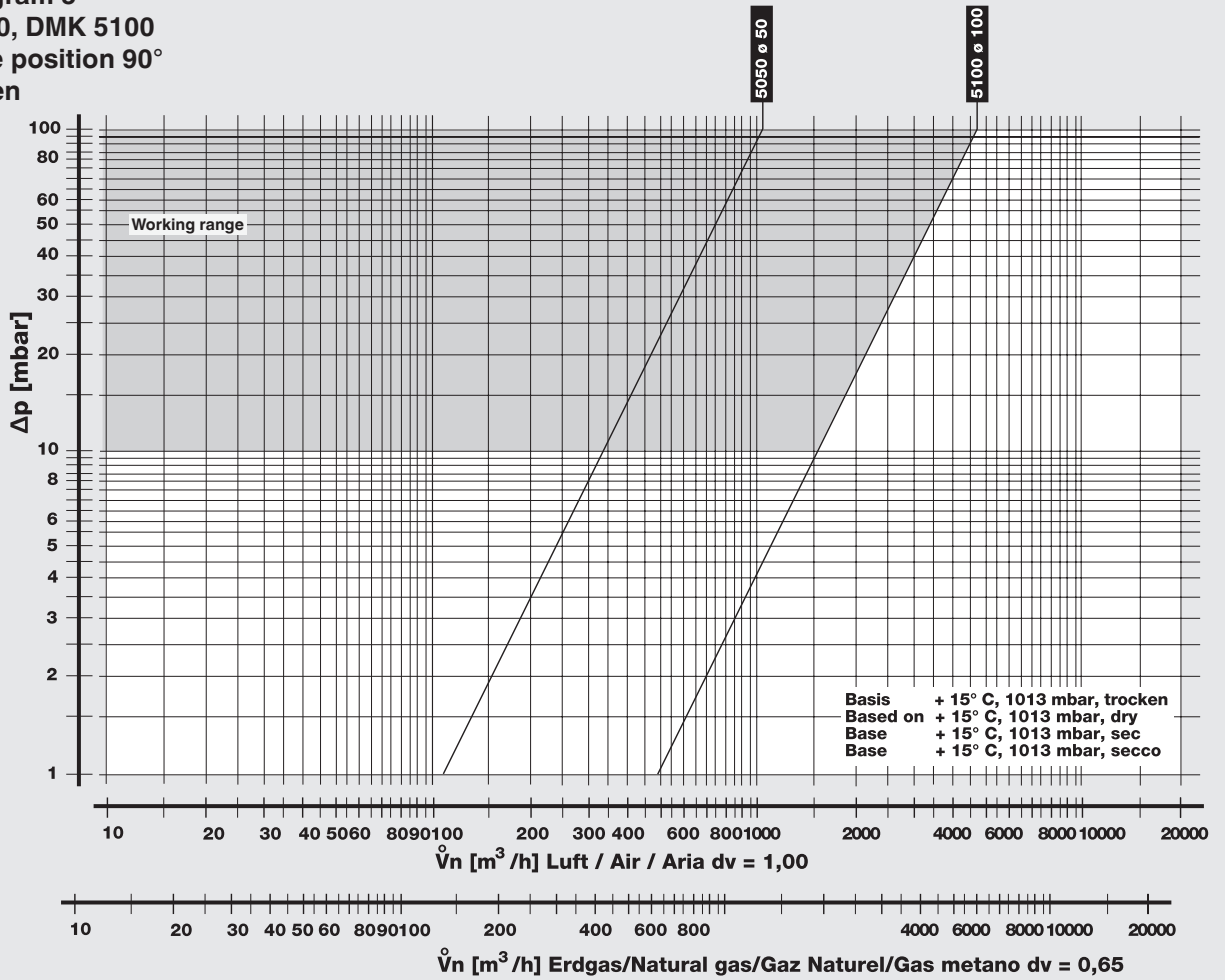

Flow diagram 4
DMK 5065, DMK 5125
 V_{max} valve position 90°
 Valve open

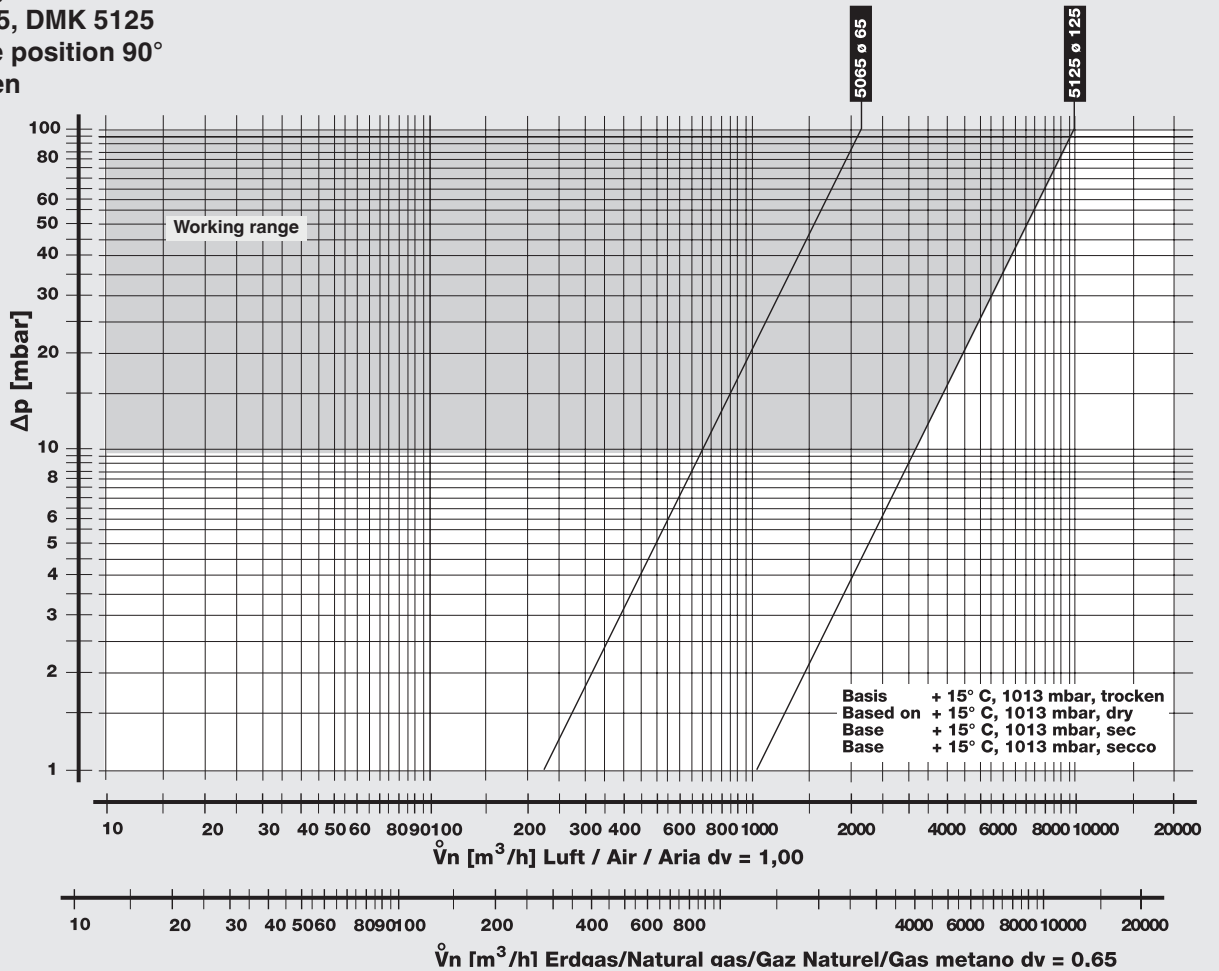

**Motorised butterfly valve
DMK
Nominal diameters DN 40 to DN 125**



**Dimensions [mm]
DMK 5040-P/Q - 5125-P/Q**

DMK...-P

DMK...-Q

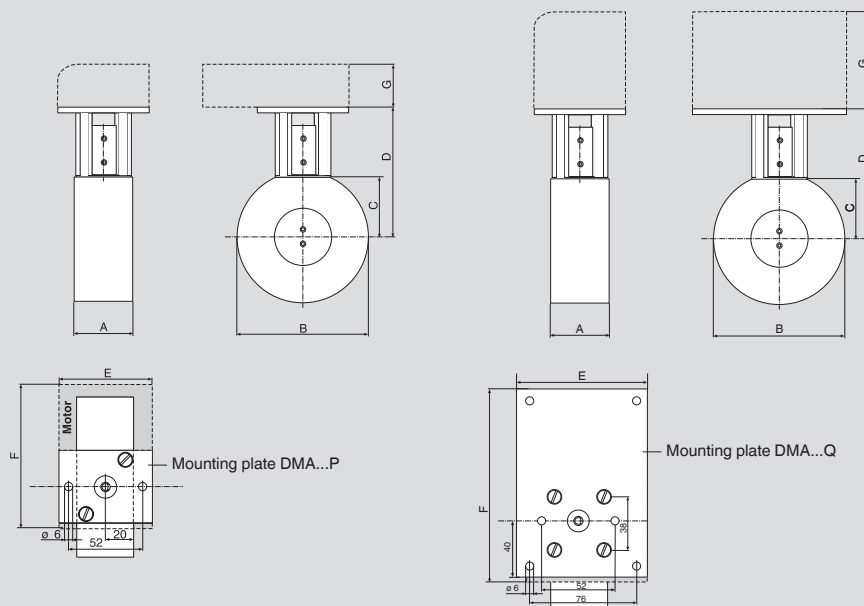

Type	DN	ø [mm]	A	B	C	D	Order No. DMK...-P	Order No. DMK...-Q
DMK 5040	40	40	40	93	42	92	225 975	on request
DMK 5050	50	50	40	105	48,5	98,5	225 978	on request
DMK 5065	65	65	40	125	59,5	109,5	225 981	254 018
DMK 5080	80	80	40	140	67	117	225 984	254 019
DMK 5100	100	100	40	160	77	127	225 987	254 020
DMK 5125	125	125	40	192	89,5	139,5	225 990	on request

Actuators Type		E	F	G	ø _{Shaft}	Comment	Order No.
DMA 40 P 230/02 3	IP 40	65	99	66	8		226 240
DMA 40 P 230/02 4	IP 40	65	99	114	8		238 810
DMA 30 P 230/03 0	IP 40	65	99	114	8		226 239
DMA 30 Q 230/10 3	IP 54	90	136	149	10		252 723
DMA 30 Q 230/10 0	IP 54	90	136	149	10		252 721

When ordering, please specify actuator!

We reserve the right to make any changes in the interest of technical progress.



**Head offices and factory
Karl Dungs GmbH & Co. KG
Siemensstraße 6-10
D-73660 Urbach, Germany
Telefon +49 (0)7181-804-0
Telefax +49 (0)7181-804-166**

**Postal address
Karl Dungs GmbH & Co. KG
Postfach 12 29
D-73602 Schorndorf, Germany
e-mail info@dungs.com
Internet www.dungs.com**