

Motorised Butterfly Valve DMK

Nominal Diameter Rp 3/4 - Rp 2

11.10

DUNGS[®]
Combustion Controls

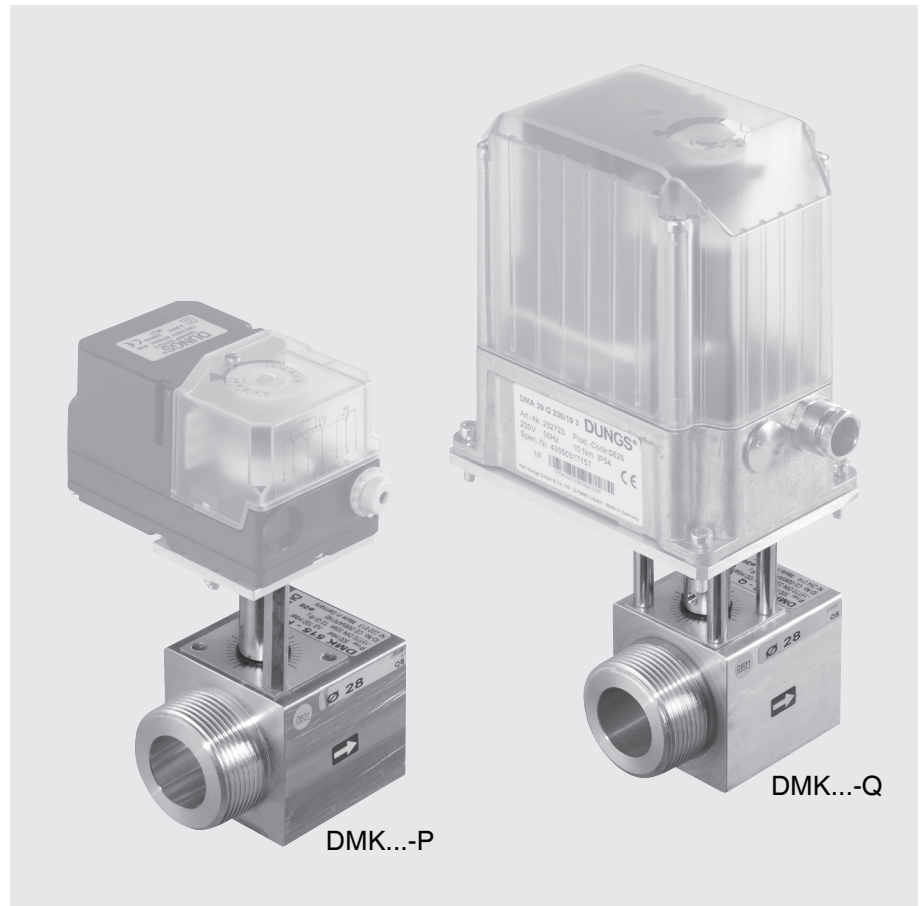

Technical description

The DUNGS DMK motorised butterfly valve is an actuator without zero shut-off as per DIN 3394, Sheet 2. Input-side male thread and output-side female thread enable a space-saving assembly directly on DUNGS multiple actuators, solenoid valves and other actuators:

- Max. operating pressure: 500 mbar (50 kPa)
- Max. differential pressure: 100 mbar (10 kPa)
- Group R₀ as per DIN 3394, Sheet 2.
- Application-specific throat diameter selection of throttle valves
- Standard actuator drives:
DMA...P..., DMA...Q...
other drives installed on request
- Reduced installation length by combination of female and male threads
- Functional, rugged and maintenance-free
- Low weight

Application

The DUNGS DMK motorised butterfly valve is used for regulating the gas supply on gas burners and gas equipment.

The motorised butterfly valve can be used for gases of families 1, 2, 3 and other neutral gaseous media.

Does not contain any non-ferrous metals, suitable for gases of up to max. 0.1 vol.% H₂S, dry.

Approval

EC type test approval as per EC Gas Appliance Directive:

DMK 5... CE-0085 AP0165
Approvals in other important gas consuming countries.

DMK Actuator without zero shut-off for regulating tasks. Prepared for mechanical and electromechanical actuator drives.

Specifications of type DMK ...

Pipe thread as per ISO 7/1	DN	20	25	32	40	50	
	R	3/4	1	1 1/4	1 1/2	2	Male thread at input
	Rp	3/4	1	1 1/4	1 1/2	2	Female thread at output

Max. differential pressure 500 mbar (50 kPa)

Max. difference pressure 100 mbar (10 kPa)

Actuator Actuator as per DIN 3394, Sheet 2, Group R₀

Gap volumetric flow in position closed (0°) see Diagram 1

Torque min. 50 Ncm

Actuator angle max. 90°

Diameter of throat	DMK 507	10 – 17 mm	Preferred diameter	11, 13, 15, 17
	DMK 510	15 – 21 mm	Preferred diameter	15, 17, 19, 21
	DMK 512	15 – 25 mm	Preferred diameter	15, 17, 19, 21, 23, 25
	DMK 515	22 – 34 mm	Preferred diameter	24, 26, 28, 32
	DMK 520	32 – 46 mm	Preferred diameter	32, 36, 40, 46

Materials of gas-conveying parts
 Housing: aluminium
 Shaft: steel
 Seals: NBR

Ambient temperature – 15 C° to + 70 C°

Installation position
 Use with actuator drive, type DMA... P/Q... any installation position
 Use with other actuator drives: refer to specifications of actuator drive

Specifications of actuator drives Type DMA... P/Q... see Data Sheet 11.20

Functional description

The DUNGS motorised butterfly valve is an automatic actuator driven by auxiliary energy.

The electromechanical actuator drive determines the position of the valve. Partial load and full load setting of the valve are specified by adjusting the switching cams of the actuator drive. The acting time is specified by selecting the actuator drive.

If the operating voltage (auxiliary energy) is interrupted, the actuator remains in its current position.

Installation

- When installing, refer to the flow direction arrow on the housing.
- Keep to the specified installation position.
- Do not use actuator as lever when screwing unit in. Use suitable tools on housing.

 **Perform leakage and functional tests after mounting.**

 **Direct contact between hardening masonry, concrete walls, floors and motorised butterfly valve is not permitted.**

 **Set pressure reference value on gas pressure regulator. Only perform load reduction via motorised butterfly valve.**

k_v values of valves with preferred throat diameter

Preferred diameter [mm]	DMK 507		DMK 510		DMK 512		DMK 515		DMK 520	
	90°	0°	90°	0°	90°	0°	90°	0°	90°	0°
ø 11	3.98	0.23								
ø 13	6.34	0.28								
ø 15	9.59	0.32	7.0	0.32	6.58	0.32				
ø 17	14.14	0.36	10.0	0.36	10.00	0.36				
ø 19			15.3	0.40	13.81	0.40				
ø 21			20.6	0.45	17.88	0.45				
ø 23					22.59	0.59				
ø 24							21.45	0.51		
ø 25					29.9	0.53				
ø 26							27.63	0.55		
ø 28							34.13	0.60		
ø 32							48.27	0.68	40.63	0.68
ø 36									56.07	0.77
ø 40									76.39	0.85
ø 46									116.21	0.89

Equipment selection

The following values must be known for the DMK rating:

1. Maximum volumetric flow V_{max} .
2. Pressure loss Δp at maximum volumetric flow.
3. Minimum volumetric flow V_{min} .
4. Pressure loss Δp at minimum volumetric flow

The throat diameter can be determined optionally using the k_v value or the diagrams 1, 2 and 3. Check whether the required minimum volumetric flow is attained in valve position 0°. If the calculated or read-off value is below the specified minimum volumetric flow, the valve can be used.

At smaller volumetric flows, the pressure loss of upstream equipment is reduced and the available Δp of the valve increases. Always select the valve with the largest Δp pressure loss ($\Delta p > 10$ mbar) to achieve a good regulating behaviour.

k_v values for DMK motorised butterfly valve

The DMK motorised butterfly valve is limited by the following parameters:
 Operating pressure $p_{max.} = 500$ mbar
 Pressure loss $\Delta p_{max.} = 100$ mbar
 For use in the area of subcritical flow

condition, the following applies:

$$V_n = 514 \cdot k_v \cdot \sqrt{\frac{\Delta p \cdot p_2}{\rho_n \cdot T_1}}$$

V_n [m³/h] volumetric flow, normal state
 Δp [bar] pressure loss via DMK
 p_2 [bar] pressure downstream of DMK, absolute
 ρ_n [kg/m³] standard density of gas
 T_1 [K] gas temperature upstream of DMK, absolute

Flow diagram 1

DMK 507 - DMK 520

$V_{min.}$ valve position 0° , valve closed

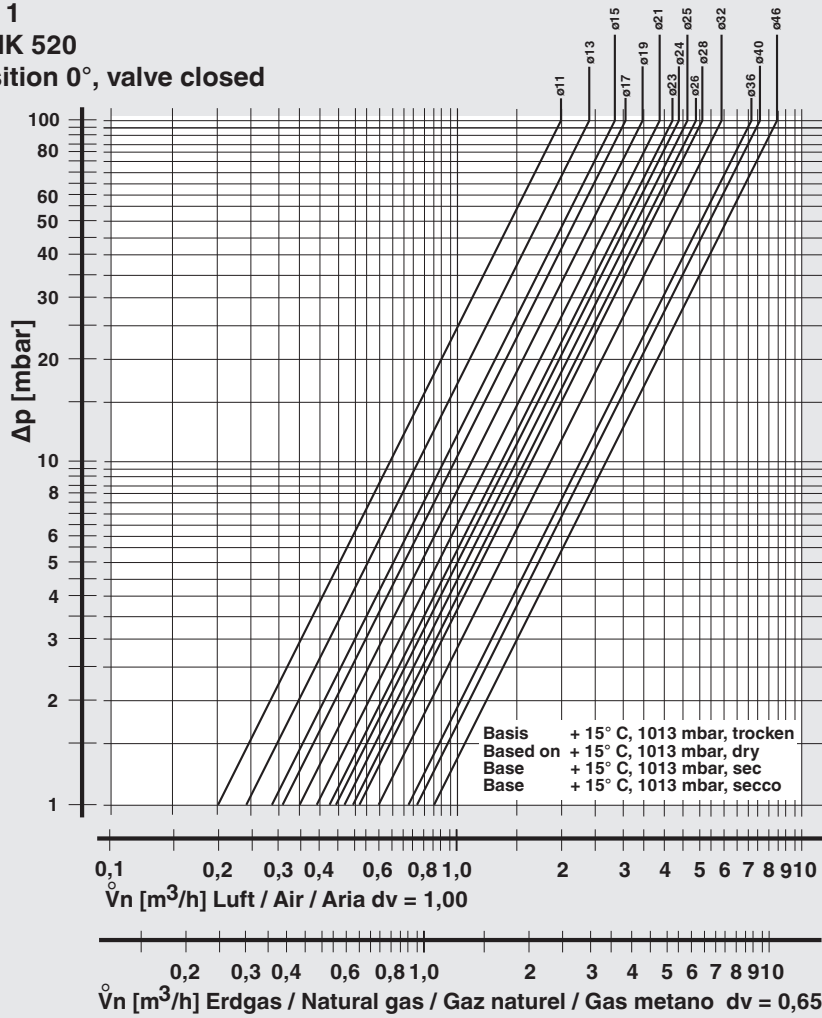

Flow diagram 2

DMK 510

$V_{max.}$ valve position 90° , valve open

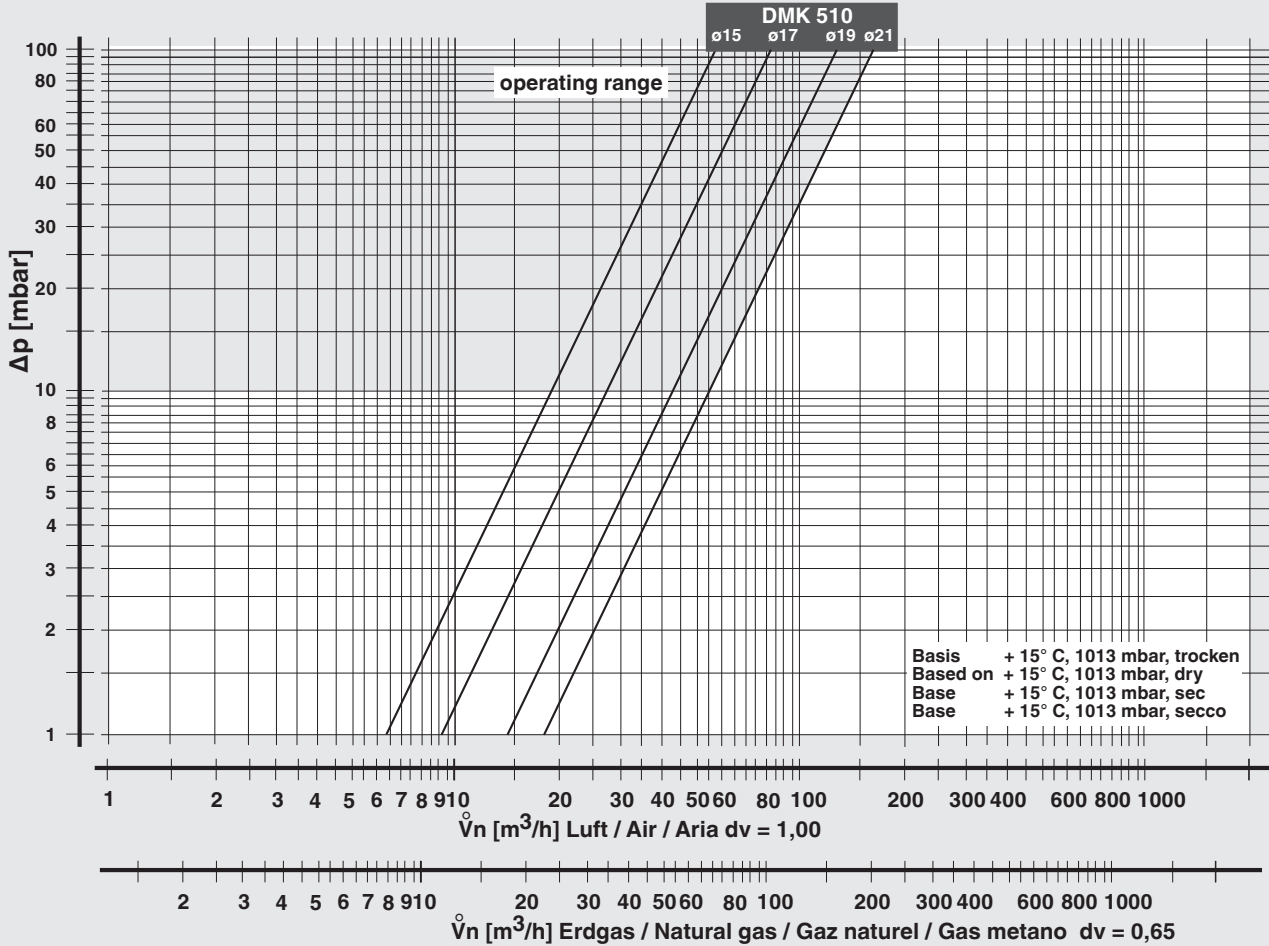

Flow diagram 3

DMK 507 - DMK 510

V_{max} valve position 90°, valve open

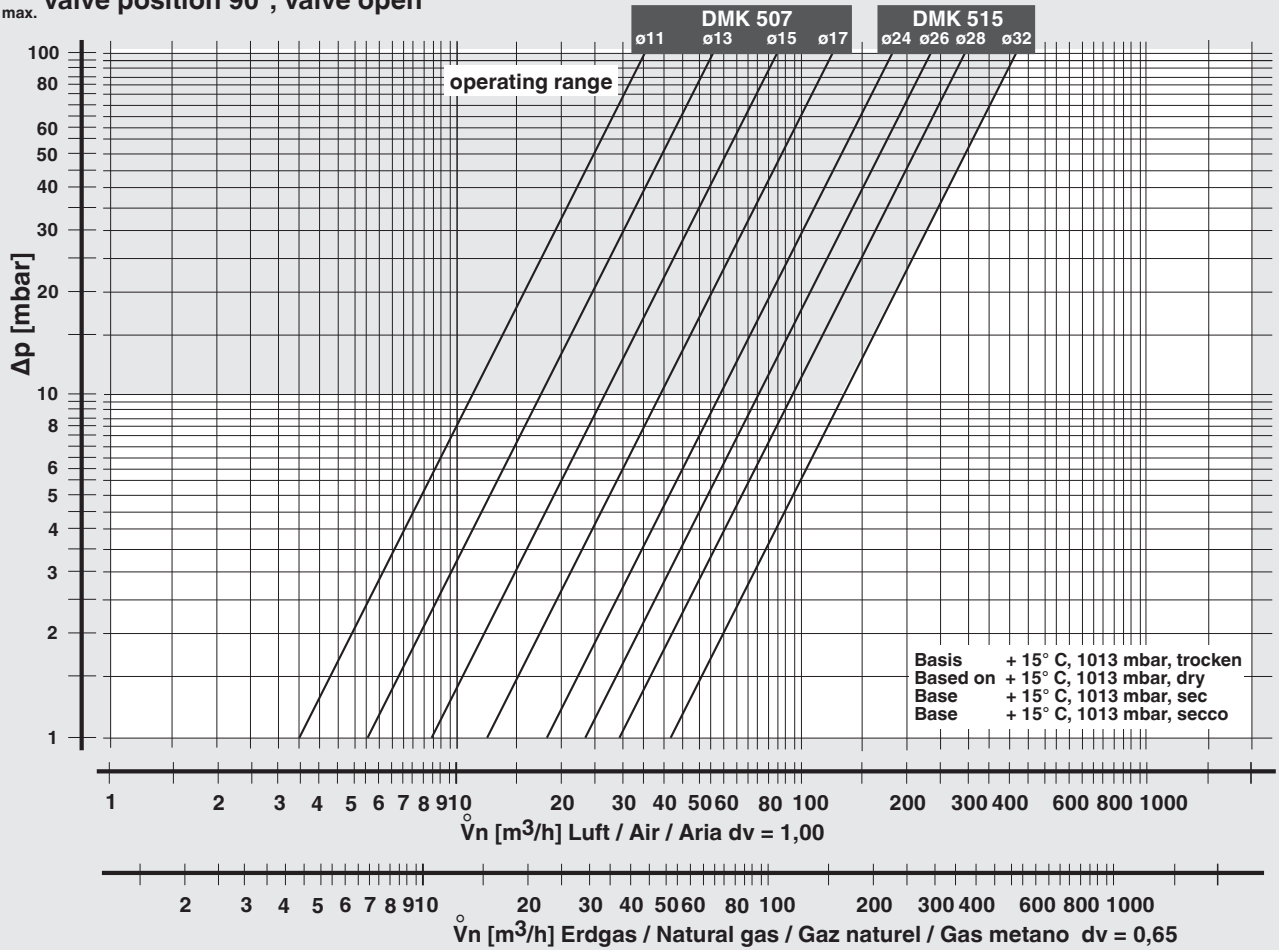

Flow diagram 4

DMK 512, DMK 520

V_{max} valve position 90°, valve open

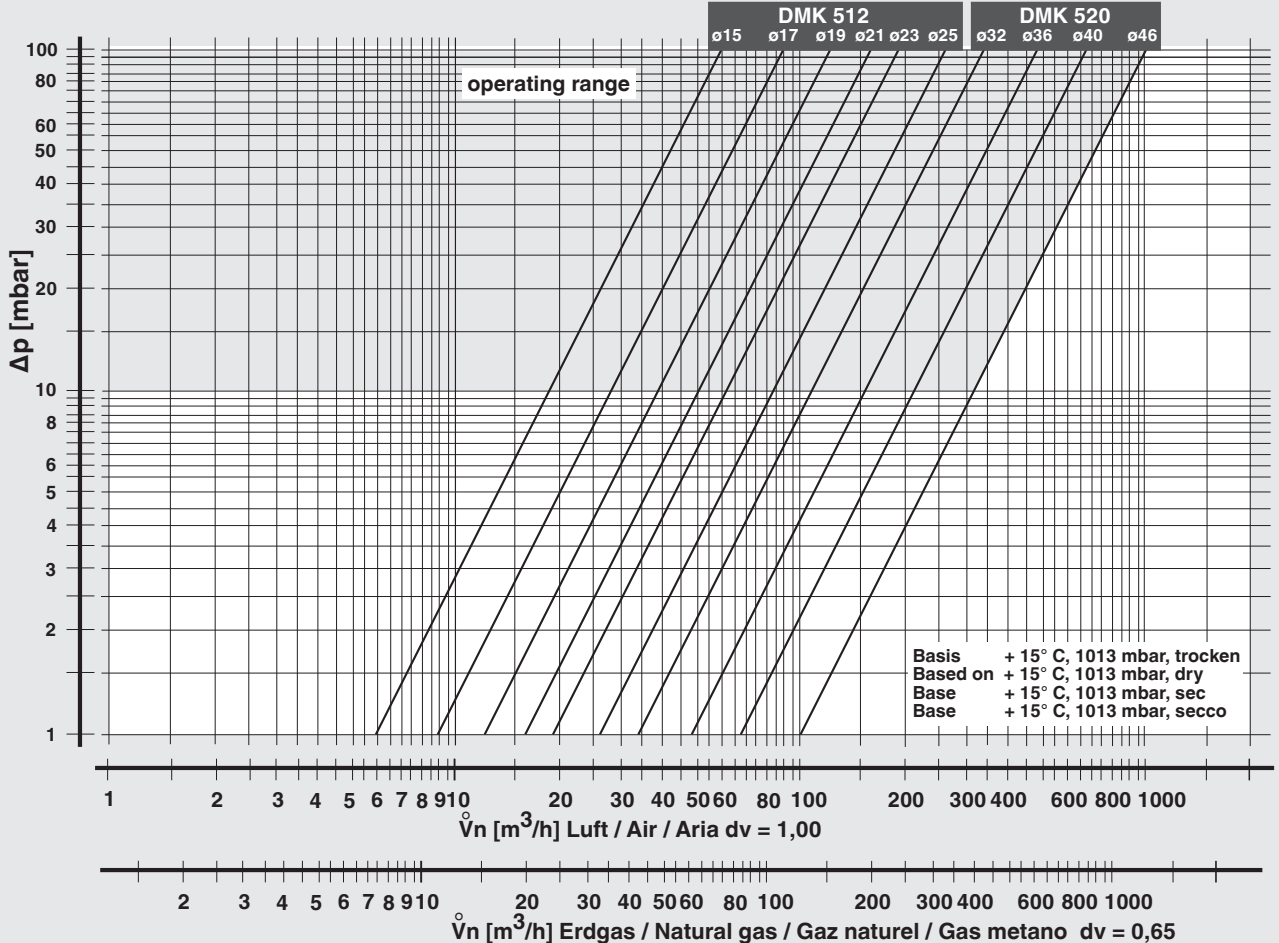

Motorised Butterfly Valve DMK



Dimensions [mm]				
DMK 507-P/Q – 520-P/Q				
	A	B	C	D
DMK 507	59,0	76,0	40,0	70,0
DMK 510	67,5	86,5	50,0	75,0
DMK 512	66,0	86,5	50,0	75,0
DMK 515	66,0	90,0	60,0	80,0
DMK 520	70,0	98,0	75,0	87,5

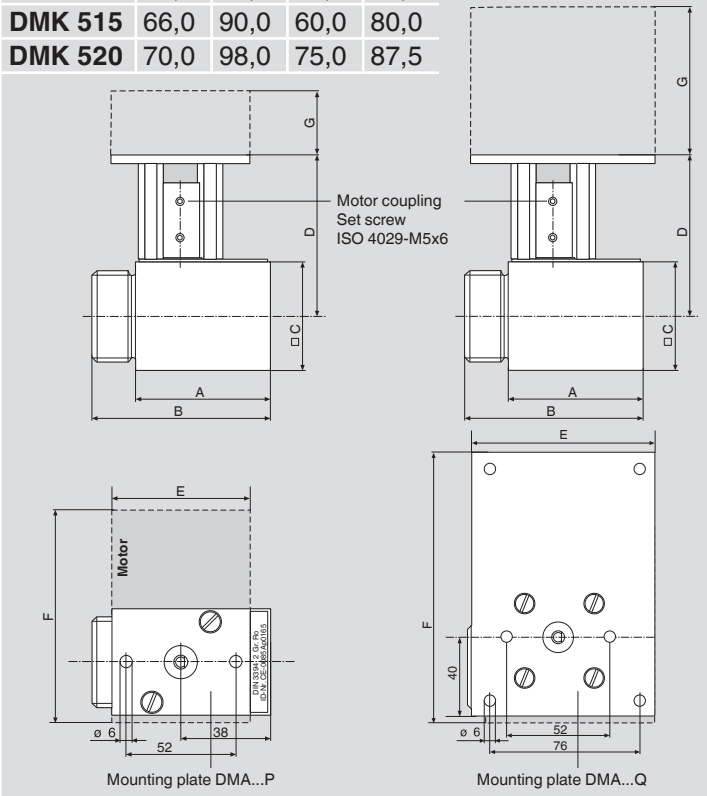

Type	Rp/R	ø [mm]	Order No. DMK...-P	Order No. DMK...-Q
DMK 507	3/4	11	221 041	-
DMK 507	3/4	13	222 621	-
DMK 507	3/4	15	222 620	-
DMK 507	3/4	17	222 619	-
DMK 510	1	15	221 352	on request
DMK 510	1	17	237 611	on request
DMK 510	1	19	237 612	on request
DMK 510	1	21	237 613	254 011
DMK 512	1 1/4	15	221 047	on request
DMK 512	1 1/4	17	222 618	on request
DMK 512	1 1/4	19	222 617	on request
DMK 512	1 1/4	21	222 616	on request
DMK 512	1 1/4	23	222 615	on request
DMK 512	1 1/4	25	222 614	on request
DMK 515	1 1/2	24	221 052	on request
DMK 515	1 1/2	26	222 613	on request
DMK 515	1 1/2	28	222 612	on request
DMK 515	1 1/2	32	222 611	on request
DMK 520	2	32	221 057	254 015
DMK 520	2	36	222 610	on request
DMK 520	2	40	222 609	on request
DMK 520	2	46	222 608	254 016

Actuators Type		E	F	G	ø _{Shaft}	Comment	Order No.
DMA 40 P 230/02 3	IP 40	65	99	66	8	on mounting plate DMK...-P	226 240
DMA 40 P 230/02 4	IP 40	65	99	114	8		238 810
DMA 30 P 230/03 0	IP 40	65	99	114	8		226 239
DMA 30 Q 230/10 3	IP 54	90	136	149	10	on mounting plate DMK...-Q	252 723
DMA 30 Q 230/10 0	IP 54	90	136	149	10		252 721

When ordering, please specify actuator!

We reserve the right to make any changes in the interest of technical progress.



Head Offices and Factory
Karl Dungs GmbH & Co. KG
Siemensstraße 6-10
D-73660 Urbach, Germany
Telephone +49 (0)7181-804-0
Telefax +49 (0)7181-804-166

Postal address
Karl Dungs GmbH & Co. KG
Postfach 12 29
D-73602 Schorndorf, Germany
e-mail info@dungs.com
Internet www.dungs.com